

# Quick Start Guide

## Packing List

1. iTIVO-HD x 1
2. Universal 12V Adapter x 1
3. RJ45 Pigtail Cable (default) x 1  
or RJ5-DB9 Cable x 1

### Important Note

This package does not contain application software, user menu, and other supporting documents. Please download the latest software and documents here:  
<http://www.iLinkPro.com>

## Connection

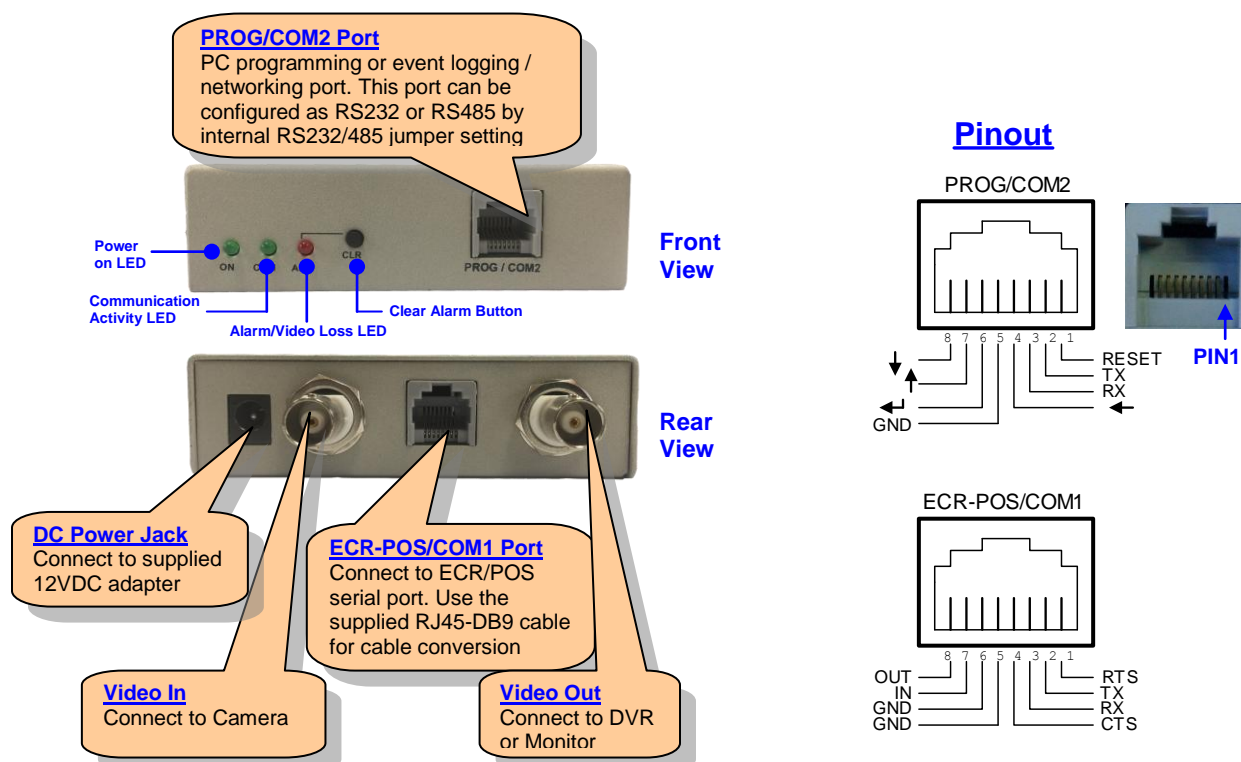

## Installing the iTIVO-HD

1. Connect *VIDEO IN* to video camera
2. Connect *VIDEO OUT* to TV monitor or digital video recorder (DVR)
3. Plug in the supplied RJ-45-DB9 cable to ECR/POS port and connect the cable to ECR, POS or PC serial port. If the cable is too short, use a standard DB9 male-female extension cable (not supplied) to extend the length.

**NOTE 1:** If the connector of your ECR/POS serial port is not DB9, you may have to make your own cable or modify the supplied cable. Refer to [Connection](#) section for pinout of iTIVO-HD.

**NOTE 2:** The supplied cable has DB9 pin2 assigned to TX (of iTIVO-HD), pin3 to RX (of iTIVO-HD) and pin5 to GND. If your cash machine is having standard serial port pinout (a.k.a DTE pinout), then it should be no problem connecting your cash machine directly to the iTIVO-HD. Please check your cash machine's hardware manual before you make any connection.

4. Plug in the supplied adapter DC jack and turn on the adapter power. Upon power on, iTIVO-HD gives a short beep and briefly displays the current firmware version on TV monitor.

## Connecting iTIVO-HD to ECR/POS

There are few ways of connecting the iTIVO-HD to your cash register. Here are some examples

1. Direct connection: This is the most common and straight forward method if there is a serial port available on your ECR/POS that can be configured as transaction data output port. Check your ECR/POS's manual to find out this possibility.
2. Printer/Pole display Emulation: This method is similar to 1 (direct connection) except that you have to short the TX jumper of iTIVO-HD (see [Jumper](#) section of iTIVO-HD [User's Manual](#)). iTIVO-HD can understand most ESC commands (or printer ESC commands) and can respond to them accordingly. In this way, the iTIVO-HD is actually emulating a "printer" or a "pole display" device. Select a pole display or printer (e.g. TM-88II) model that you would like iTIVO-HD to emulate in your ECR/POS's printer/pole display configuration (refer to relevant manual) and ensure that you can disable all hardware flow-control of the selected device in your ECR/POS. If not, you may have to make a cable, or modify the supplied cable, similar to the figure shown in [RJ45-DB9 Cable Configuration](#) section (serial cable with flow control loopback).
3. Pole display tapping: This method taps the serial TX and GND lines of a pole display that is already connected to your ECR/POS.
4. External printer tapping: This method taps the serial TX and GND lines of an external printer that is already connected to your ECR/POS.
5. Internal journal/receipt printer tapping: This method taps directly from the internal printer. It requires a special PI4ECR converter card to be installed in your ECR. Ask your local distributor about this converter card if you need more information.

**NOTE:** The default RS232 setting of iTIVO-HD is 9600 baud, 8 data bits, no parity bit and 1 stop bit. No flow control. Set your ECR/POS or PC to match this setting. Otherwise, this setting must be changed through PC programming (refer to iTIVO-HD User's Manual).

## RJ45-DB9 Cable Configuration

The supplied RJ45-DB9 cable can be used for either ECR/POS connection or PC programming. This cable only has pin2, pin3 and pin5 of DB9 connected. For printer emulation, TX jumper has to be shorted. Refer to [Connecting iTIVO-HD to ECR/POS](#) section and iTIVO-HD User's Manual about printer emulation and jumper location. The **figure on the left** shows the electrical connection of the **supplied cable**. The figure on the right is a typical connection with hardware flow control loopback, which is sometimes required in emulating a printer/pole display if hardware flow control is mandatory, depending on the model of an ECR/POS being used. Refer to [iTIVO-HD User's Manual](#) for more cabling options.

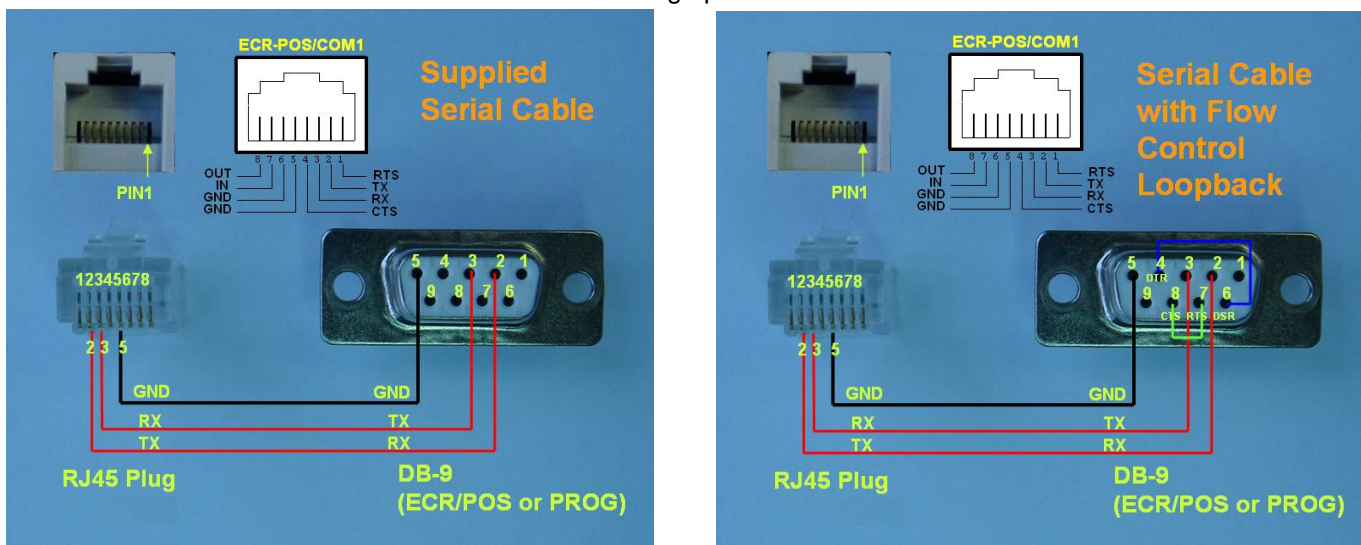

For more information and other product documents, please go to <http://www.ilinkpro.com/proddetail.php?prod=iTIVO-HD>